

A08319 - 8319 CARB. PHVA 12 QD

CARBURETOR SPARE PARTS FILE

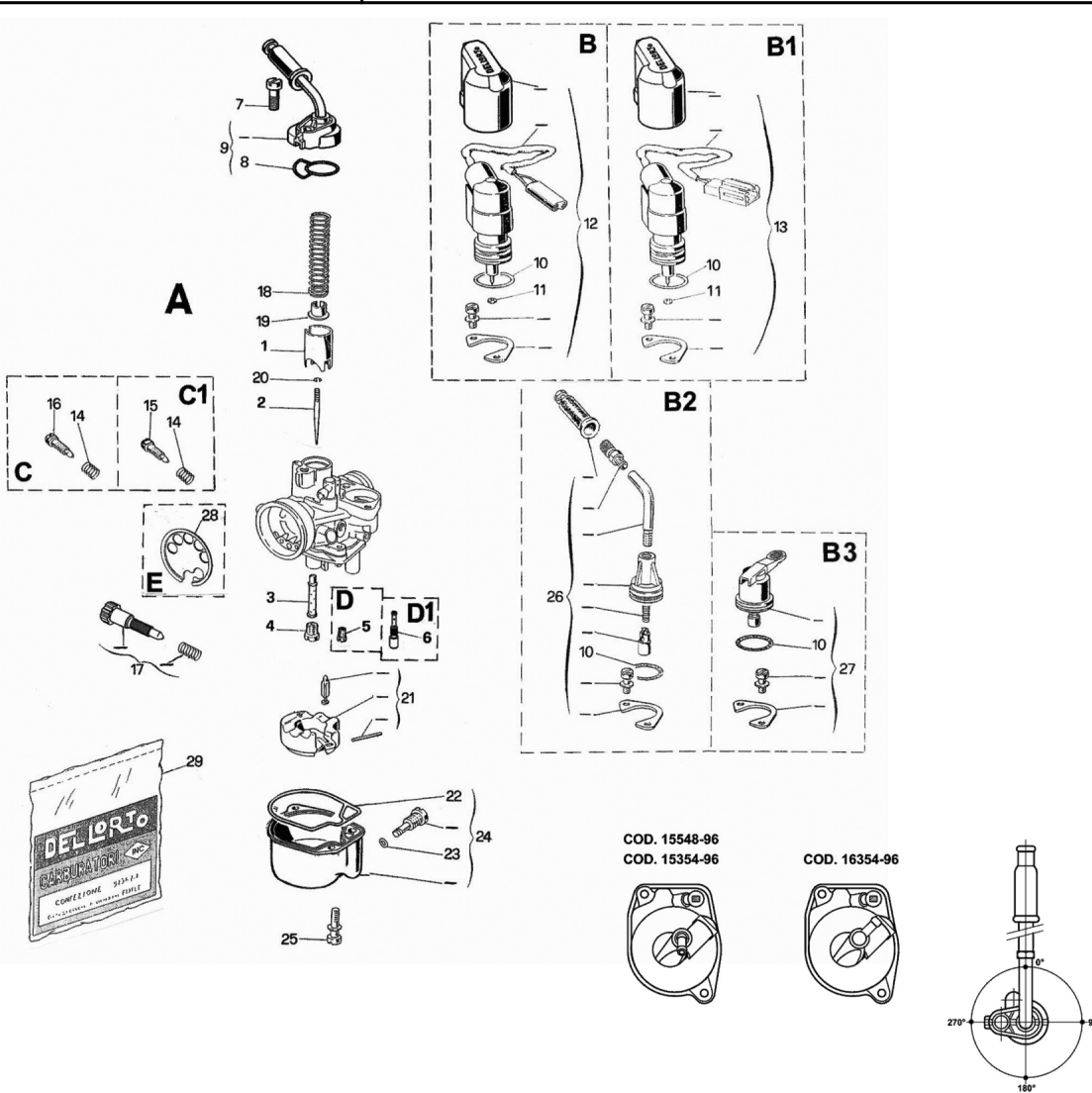

N°	Part Number	Description	Qty
0	A08319	8319 CARB. PHVA 12 QD	1
1	B14230.040	14230 SLIDE 40	1
2	B16250.026	16250 CONICAL NEEDLE A 26	1
3	B14351.210	14351 NEEDLE JET FQ 210	1
4	B06413.063	6413 MAIN JET 63	1
5	B11600.036	11600 JET 36	1
7	B07526	7526 SCREW	1
9	B14566	14566 SLIDE COVER	1
12	B53078	53078 AUTOMATIC CHOKE KIT PHVA-PHVB	1
17	B53029	53029 SCREW KIT for SLIDE REG. PHVA	1
20	B01411	1411 SPRING	1
21	B53053	53053 FLOAT KIT PHVA-PHBN	1
22	B14130	14130 SCREW	1
24	B15548	15548 BOWL	1
29	B13681	13681 CLIP	1
29	B52622	52622 GASKET KIT PHVA...B-C-D-E-G-H-L	1
33	B13709	13709 SCREW	2